

batimet
Holz-Aluminium · Systeme · Fenster · Fassade

Enderstrasse 90 | D-01277 Dresden
Telefon: +49 (0) 351.81186.0
Telefax: +49 (0) 351.81186.11
info@batimet.de | www.batimet.de

System		Datum	Name	Maßstab
batimet TA35	Gezeich.	11.04.2018	Pickel	Ansicht -
Aufdopplungsprofile Holz	Gepr.			Detail -
IV68 und IV78	Norm			
Beschreibung				
10 bis 70 mm				
		Zeichnungs-Nr.: 10001		Index: A

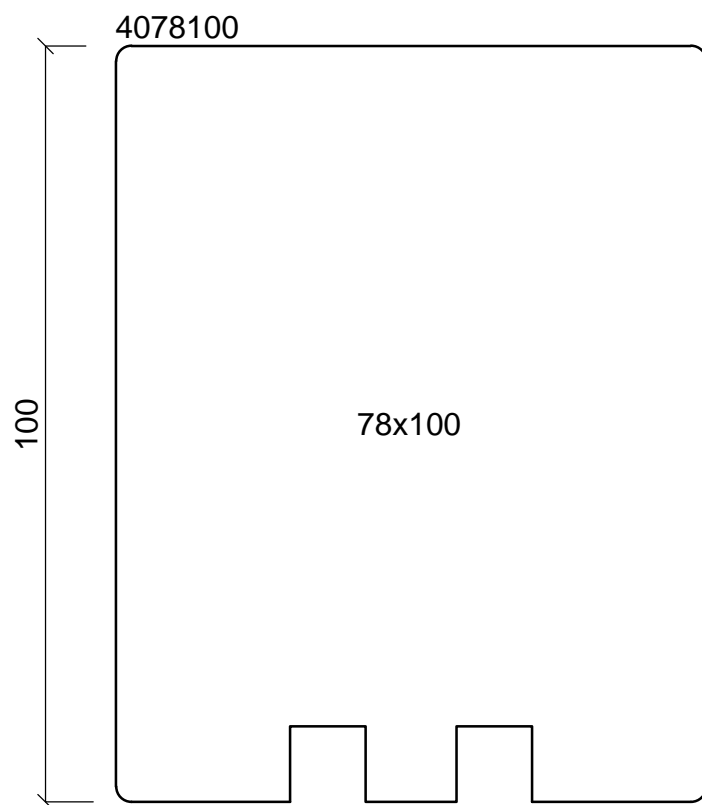
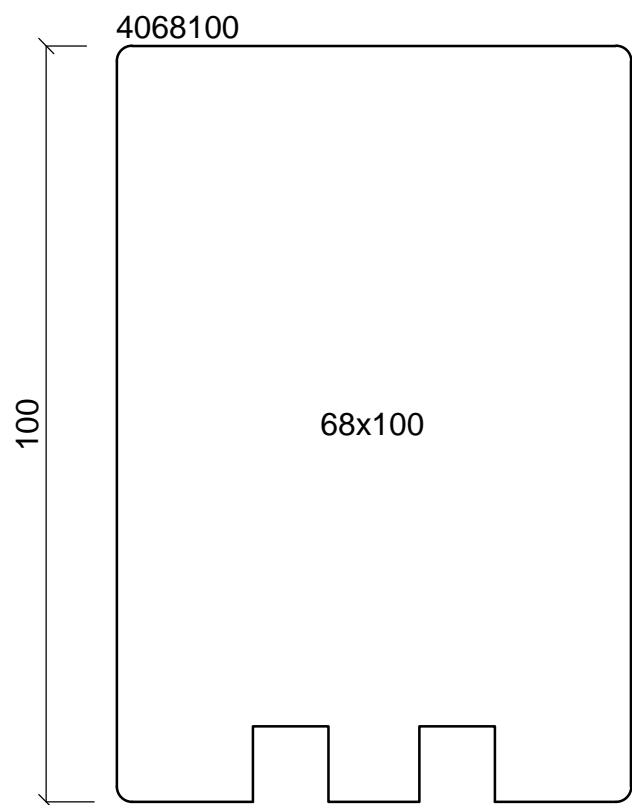
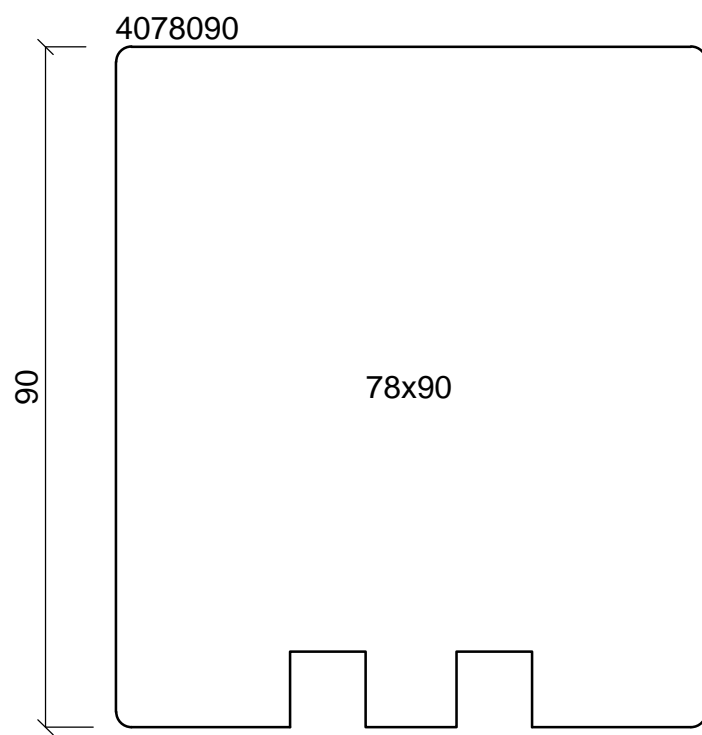
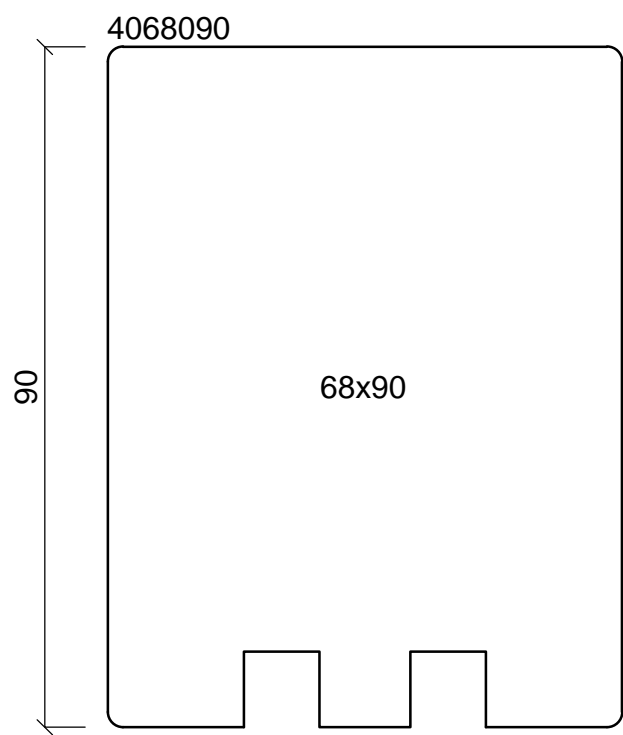
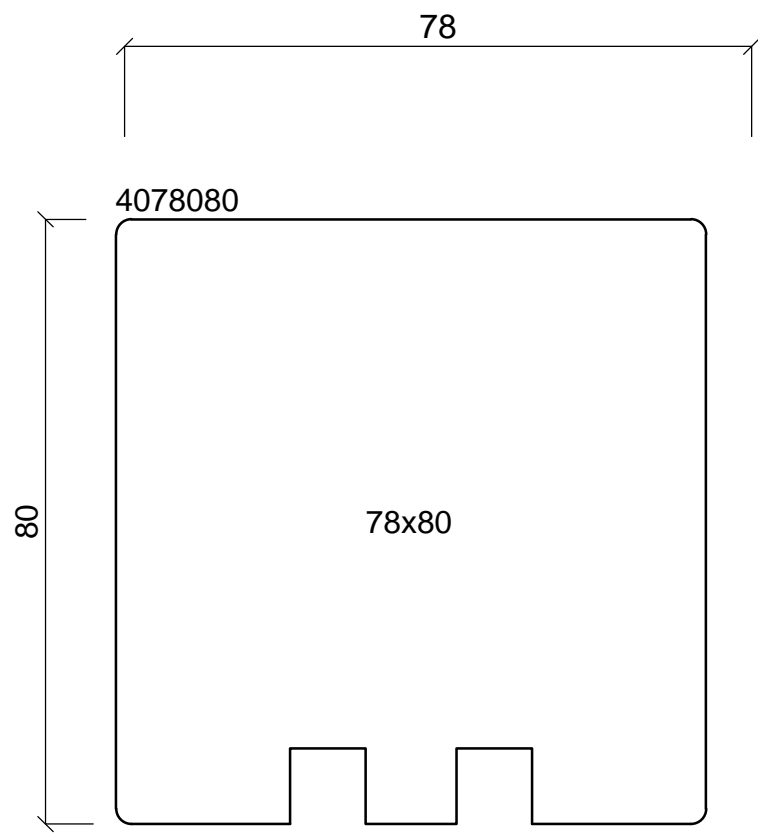
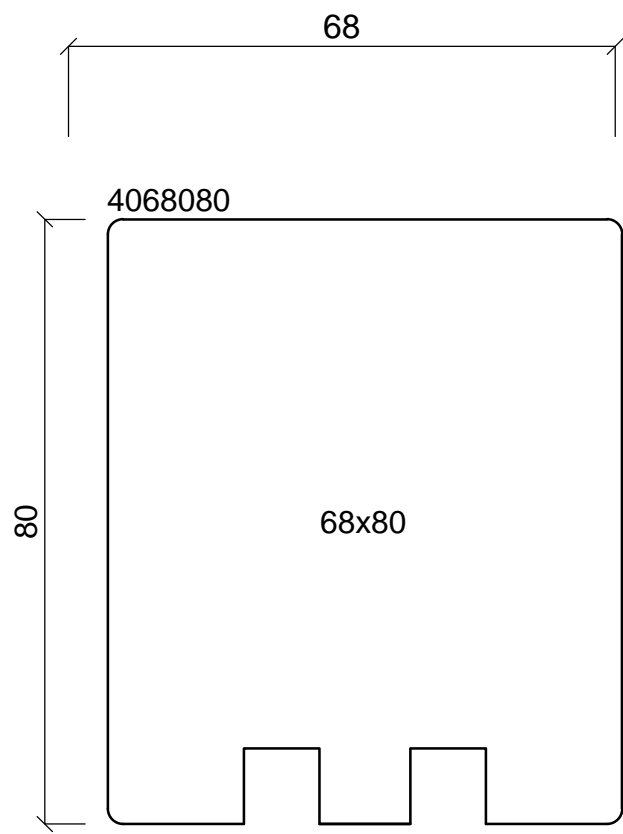

batimet
Holz-Aluminium · Systeme · Fenster · Fassade

Enderstrasse 90 | D-01277 Dresden
Telefon: +49 (0) 351.81186.0
Telefax: +49 (0) 351.81186.11
info@batimet.de | www.batimet.de

System		Datum	Name	Maßstab	
batimet TA35	Gezeich.	11.04.2018	Pickel	Ansicht	M1:1
Aufdopplungsprofile Holz	Gepr.			Detail	-
IV68 und IV78	Norm				
Beschreibung					
80 bis 100 mm	Zeichnungs-Nr.: 10002			Index: A	

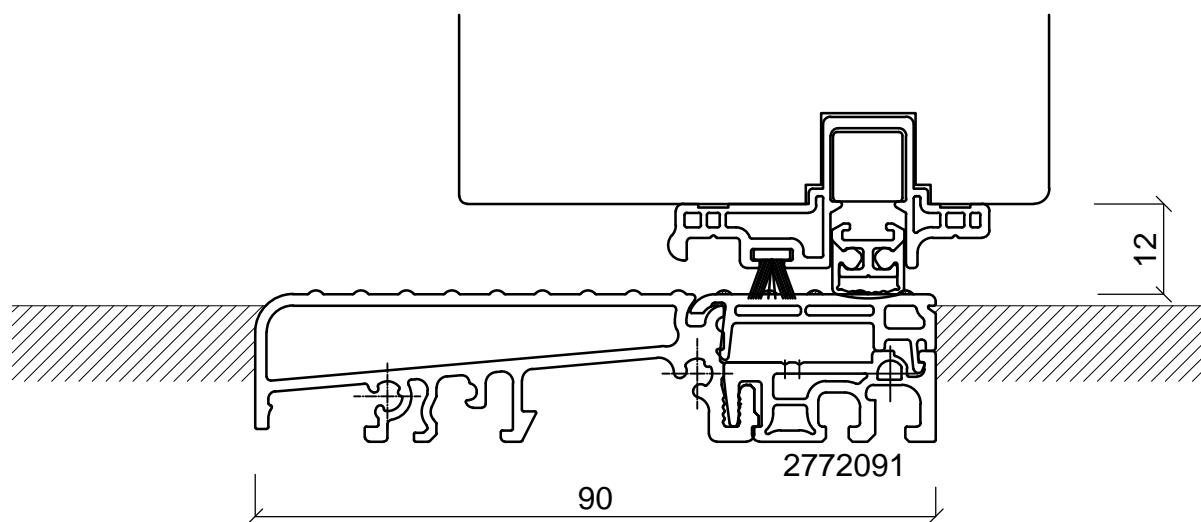
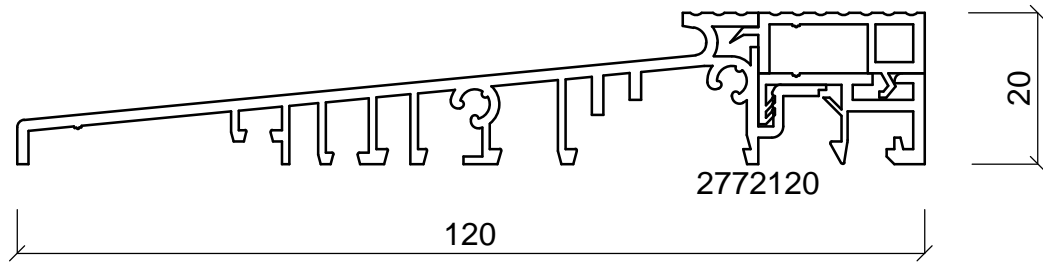
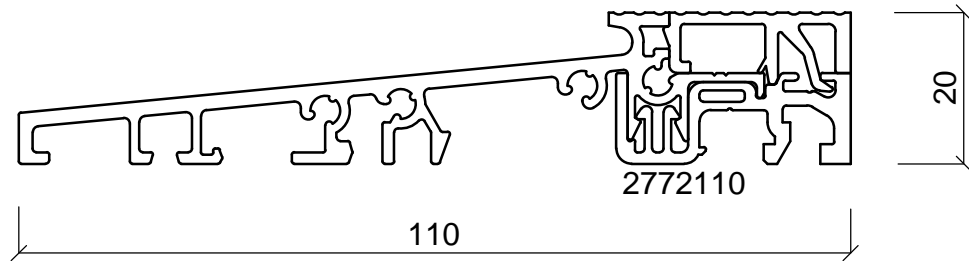
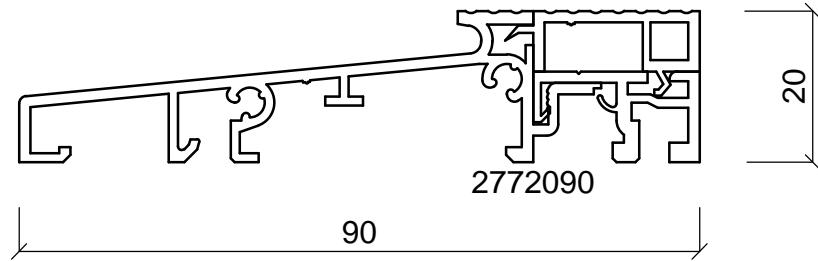
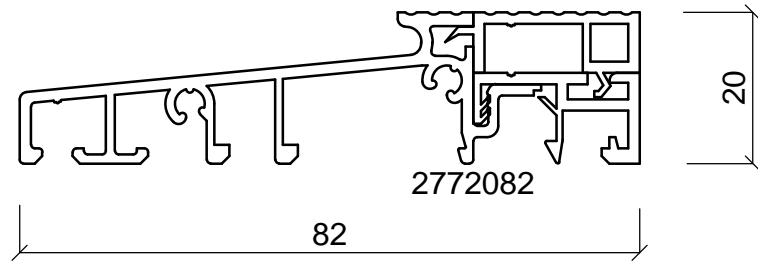
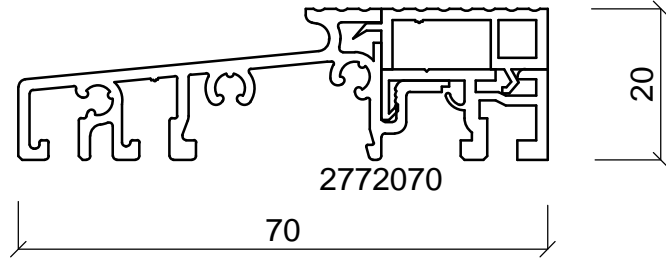
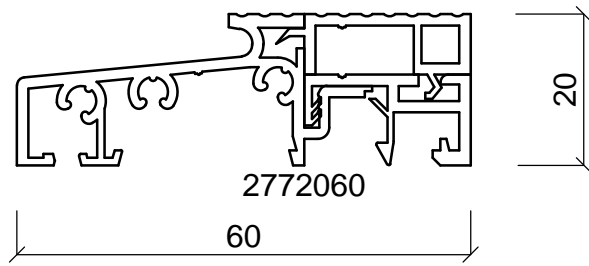

batimet
Holz-Aluminium · Systeme · Fenster · Fassade

Enderstrasse 90 | D-01277 Dresden
Telefon: +49 (0) 351.81186.0
Telefax: +49 (0) 351.81186.11
info@batimet.de | www.batimet.de

System		Datum	Name	Maßstab	
batimet TA35 Schwellen	Gezeich.	11.04.2018	Pickel	Ansicht	M1:1
	Gepr.			Detail	-
Beschreibung	Norm				
60 mm, 70 mm, 82 mm, 90 mm, 110 mm, 120 mm					
	Zeichnungs-Nr.:	10003		Index: A	

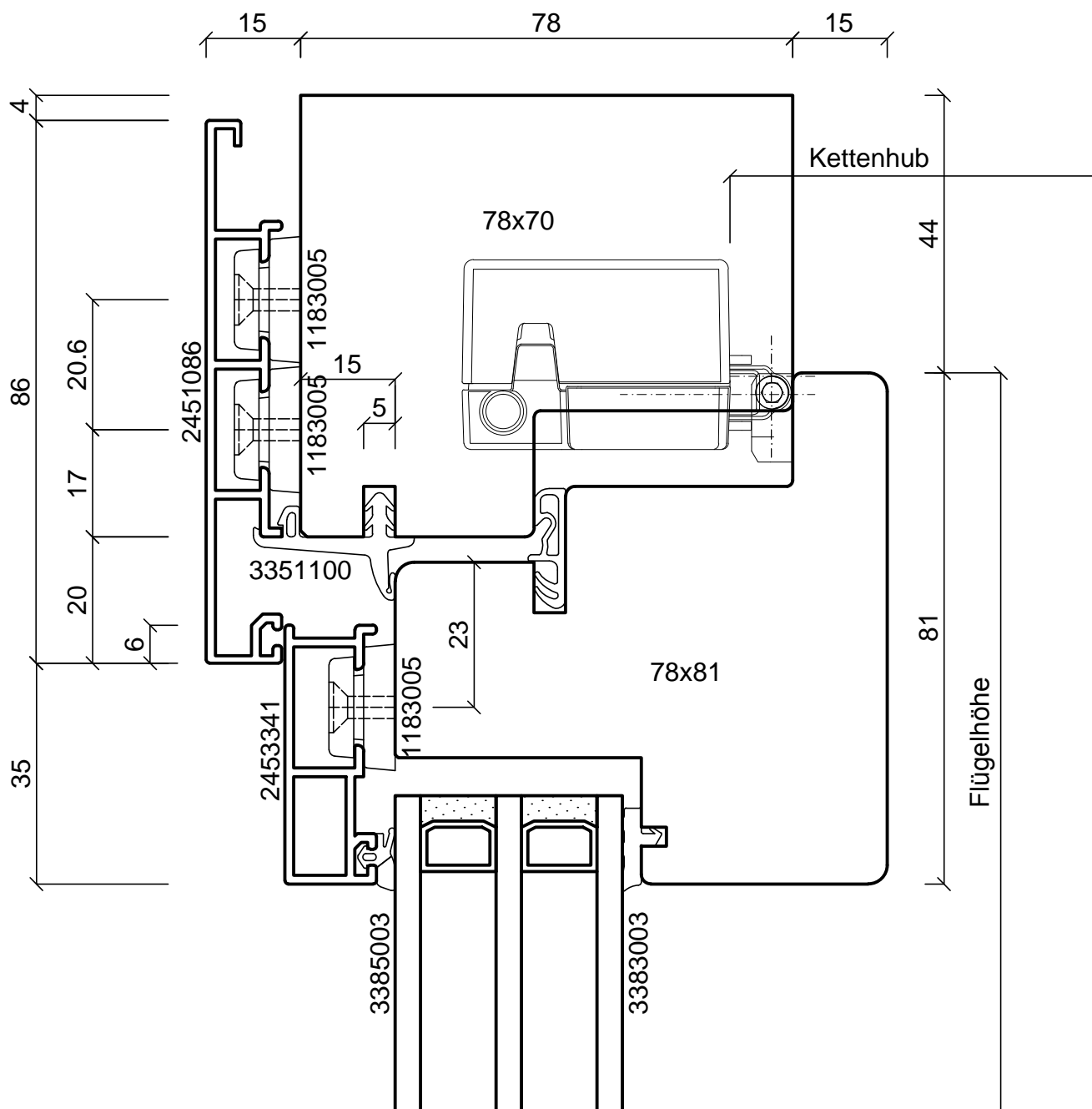

	WindowMaster	
	WMX 803	WMX 823
min. Flügelhöhe	400 mm	700 mm
max. Kettenhub	250 mm	500 mm

batimet
Holz-Aluminium · Systeme · Fenster · Fassade

Enderstrasse 90 | D-01277 Dresden
Telefon: +49 (0) 351.81186.0
Telefax: +49 (0) 351.81186.11
info@batimet.de | www.batimet.de

System	Datum	Name	Maßstab	
batimet TA35 FVNG flächenversetzt kantig Vertikalschnitt oben mit Öffnungsmotor	Gezeich.	11.04.2018	Pickel	Ansicht M1:1
	Gepr.			Detail -
Beschreibung	Norm			
WindowMaster WMX 803/823 verdeckte Montage	Zeichnungs-Nr.: 10101		Index: A	

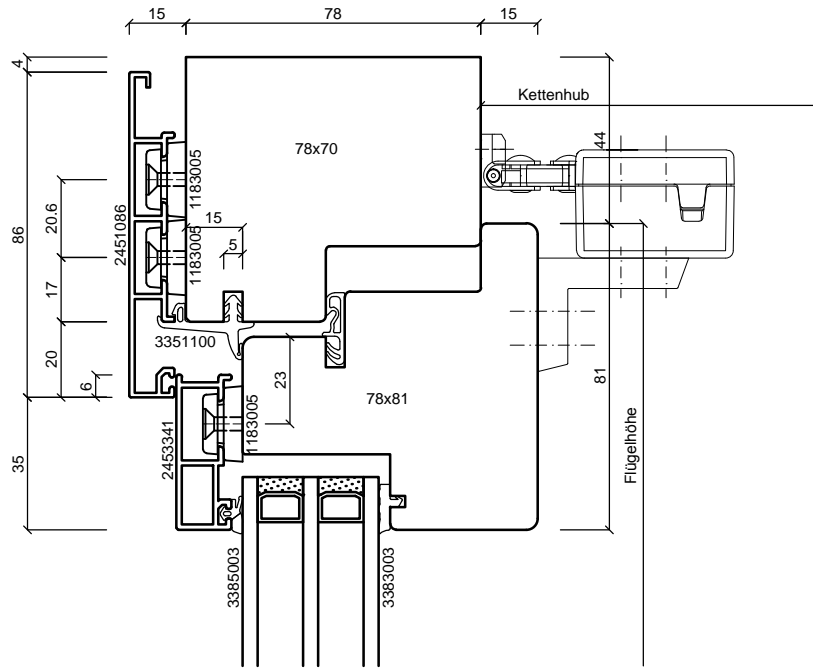

Flügelmontage

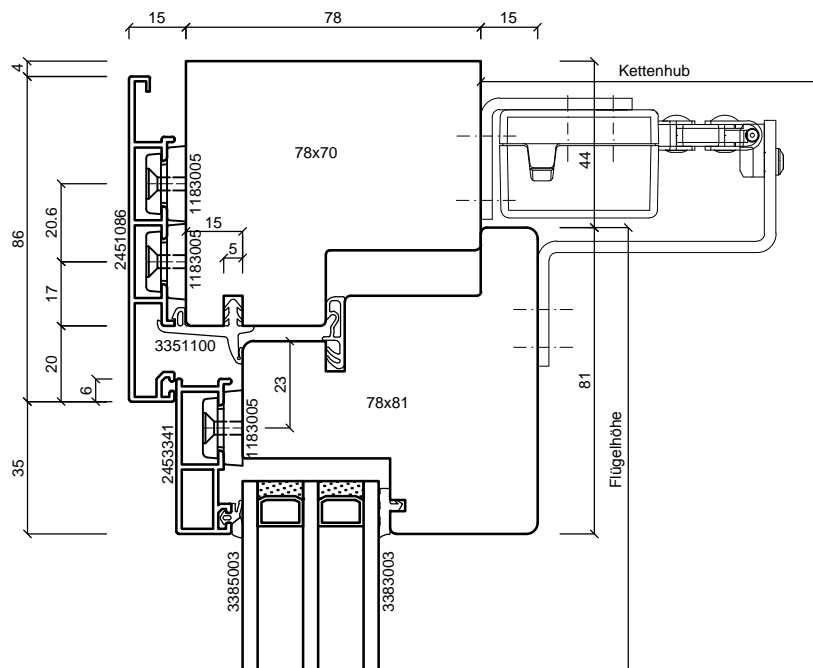

Rahmenmontage

	WindowMaster	
	WMX 804	WMX 826
min. Flügelhöhe	300 mm	700 mm
max. Kettenhub	250 mm	500 mm

batimet

Holz-Aluminium · Systeme · Fenster · Fassade

Enderstrasse 90 | D-01277 Dresden

Telefon: +49 (0) 351.81186.0

Telefax: +49 (0) 351.81186.11

info@batimet.de | www.batimet.de

System

batimet TA35 FVNG
flächenversetzt kantig
Vertikalschnitt oben mit Öffnungsmotor

Beschreibung

WindowMaster WMX 804/826
sichtbare Montage

Datum

11.04.2018

Name

Pickel

Maßstab

Ansicht M1:2

Gezeich.

Gepr.

Norm

Detail -

Zeichnungs-Nr.: 10102

Index: A

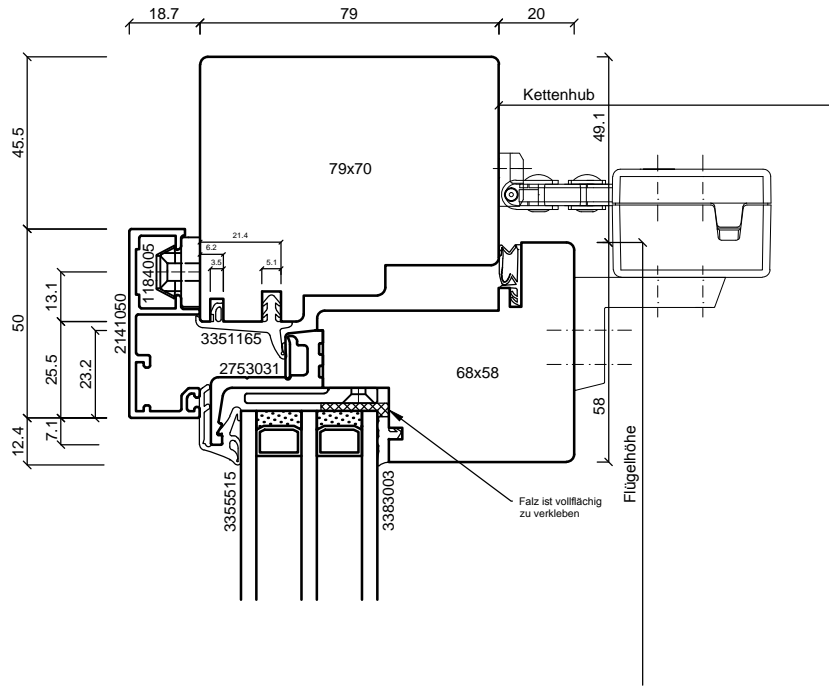

Flügelmontage

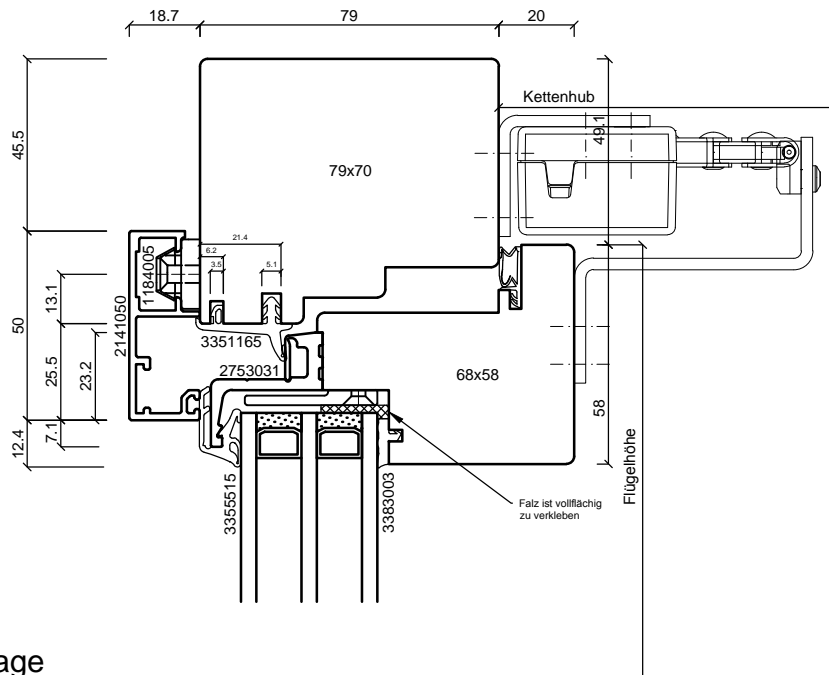

Rahmenmontage

	WindowMaster	
	WMX 804	WMX 826
min. Flügelhöhe	300 mm	700 mm
max. Kettenhub	250 mm	500 mm

batimet
Holz-Aluminium · Systeme · Fenster · Fassade

Enderstrasse 90 | D-01277 Dresden
Telefon: +49 (0) 351.81186.0
Telefax: +49 (0) 351.81186.11
info@batimet.de | www.batimet.de

System
batimet TA35 SL
slimline
Vertikalschnitt oben mit Öffnungsmotor

Beschreibung
WindowMaster WMX 804/826
sichtbare Montage

	Datum	Name	Maßstab	
Gezeich.	11.04.2018	Pickel	Ansicht	M1:2
Gepr.			Detail	-
Norm				
Zeichnungs-Nr.: 10112			Index: A	

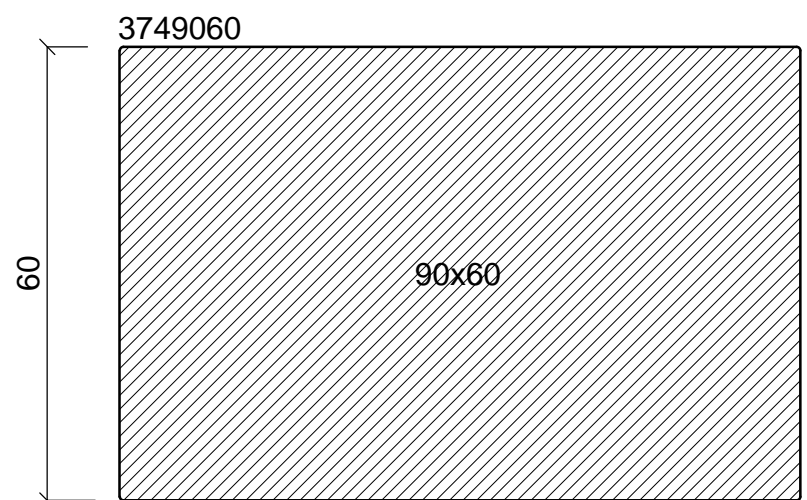
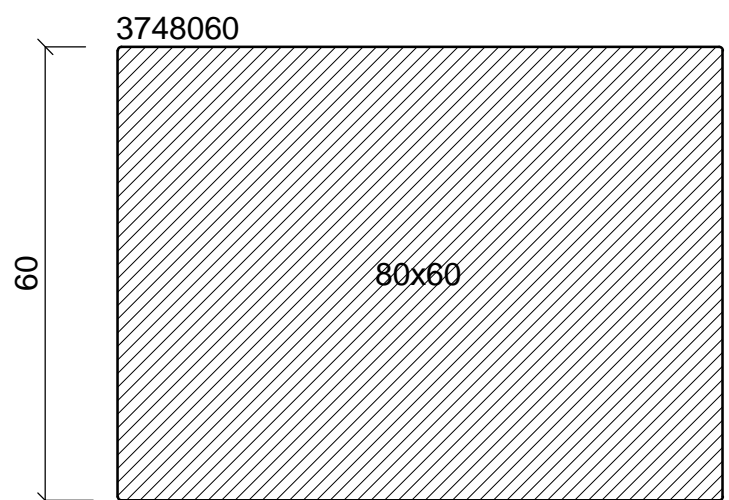
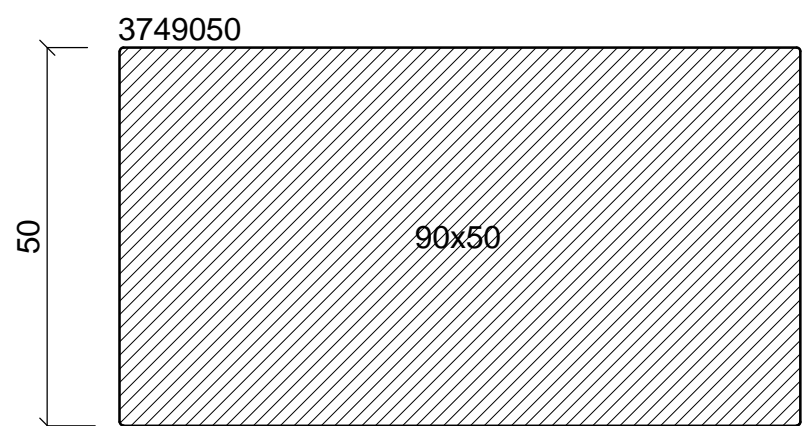
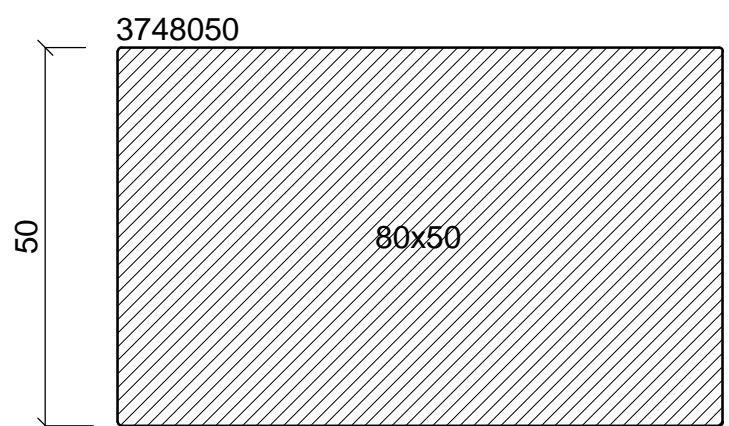
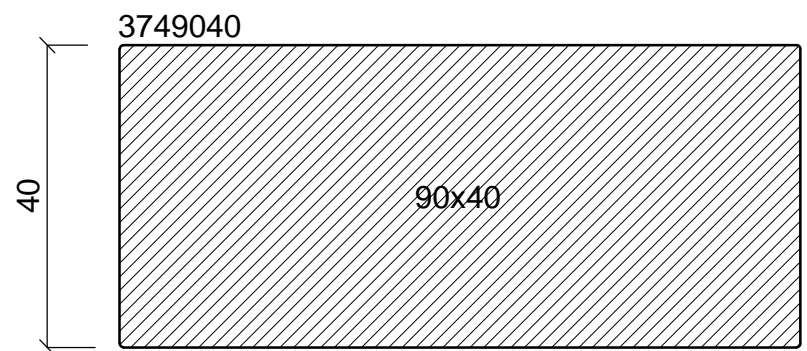
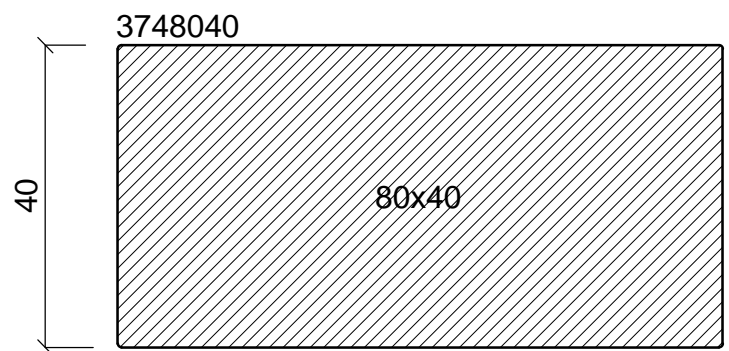
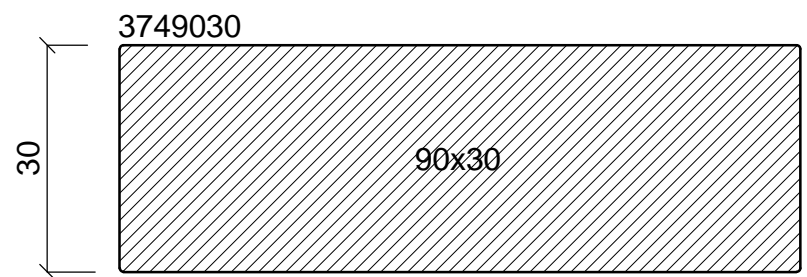
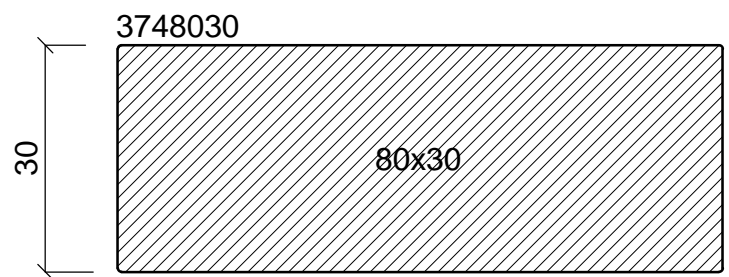
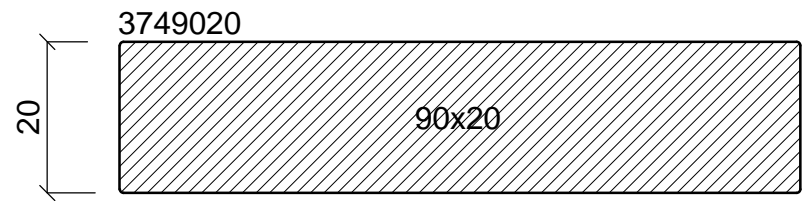
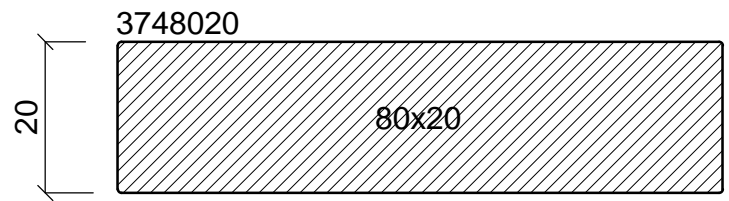
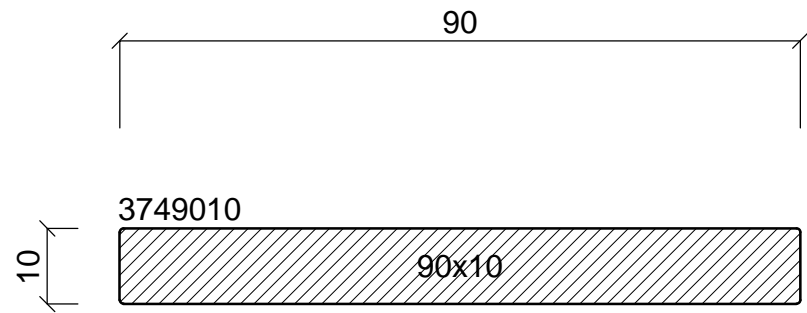
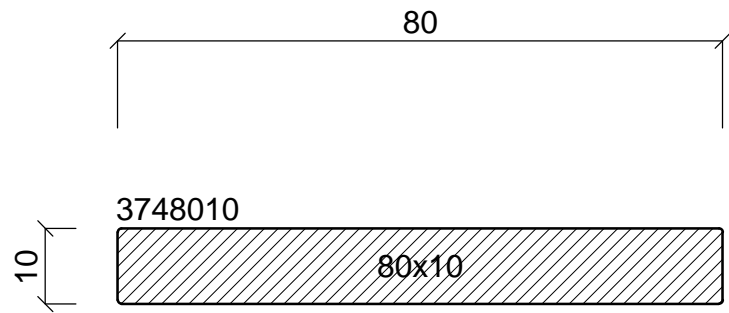

batimet
Holz-Aluminium · Systeme · Fenster · Fassade

Enderstrasse 90 | D-01277 Dresden
Telefon: +49 (0) 351.81186.0
Telefax: +49 (0) 351.81186.11
info@batimet.de | www.batimet.de

System		Datum	Name	Maßstab	
batimet TA35	Gezeich.	11.04.2018	Pickel	Ansicht	M1:1
Aufdopplungsprofile batiblock für IV68 und IV78	Gepr.			Detail	-
Beschreibung	Norm				
10 bis 60 mm					
	Zeichnungs-Nr.:	10011		Index:	A

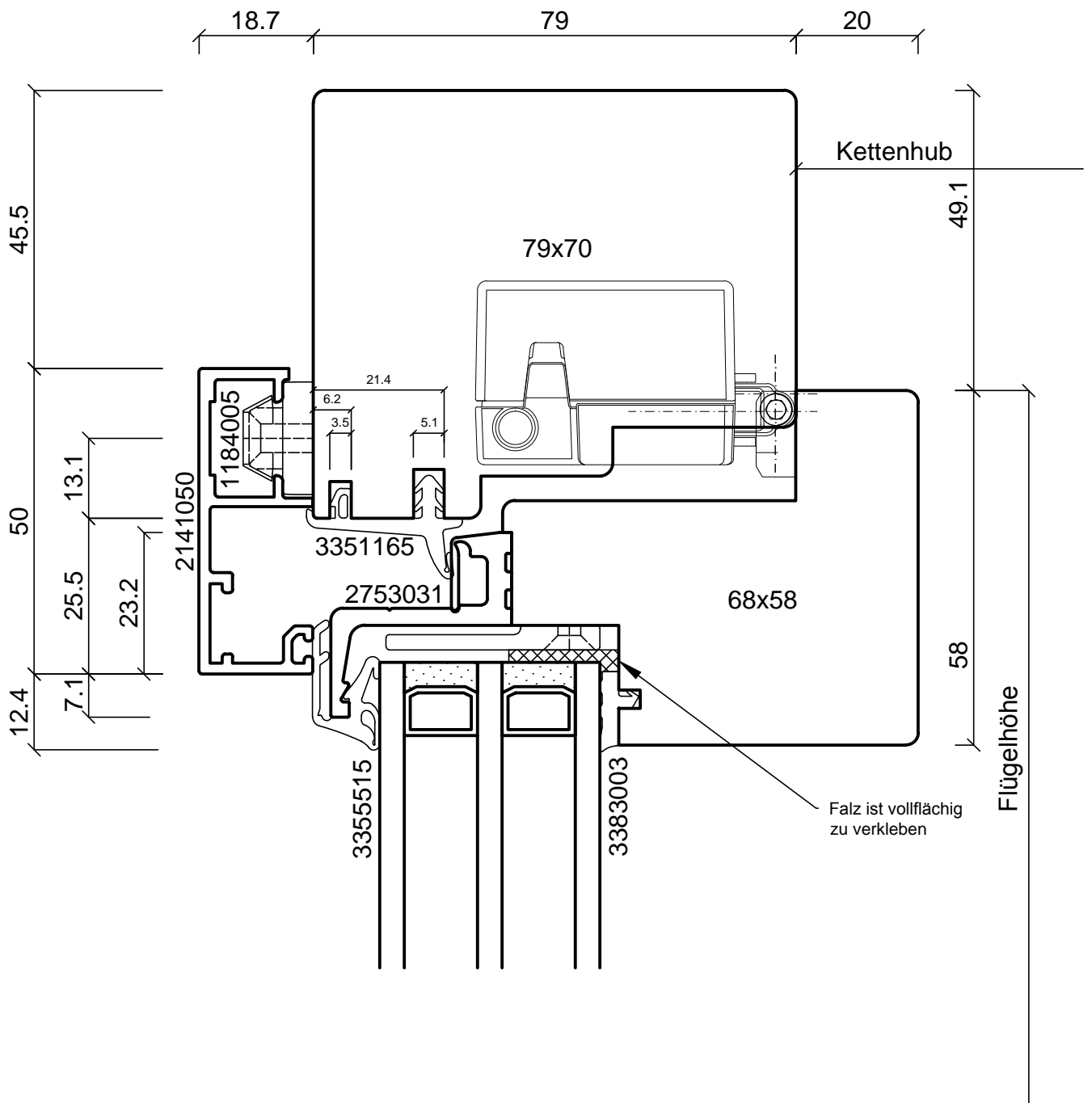

	WindowMaster	
	WMX 803	WMX 823
min. Flügelhöhe	400 mm	700 mm
max. Kettenhub	250 mm	500 mm

batimet
Holz-Aluminium · Systeme · Fenster · Fassade

Enderstrasse 90 | D-01277 Dresden
Telefon: +49 (0) 351.81186.0
Telefax: +49 (0) 351.81186.11
info@batimet.de | www.batimet.de

System	Datum	Name	Maßstab	
batimet TA35 SL slimline Vertikalschnitt oben mit Öffnungsmotor	Gezeich.	11.04.2018	Pickel	Ansicht M1:1
	Gepr.			Detail -
Beschreibung	Norm			
WindowMaster WMX 803/823 verdeckte Montage	Zeichnungs-Nr.: 10111		Index: A	

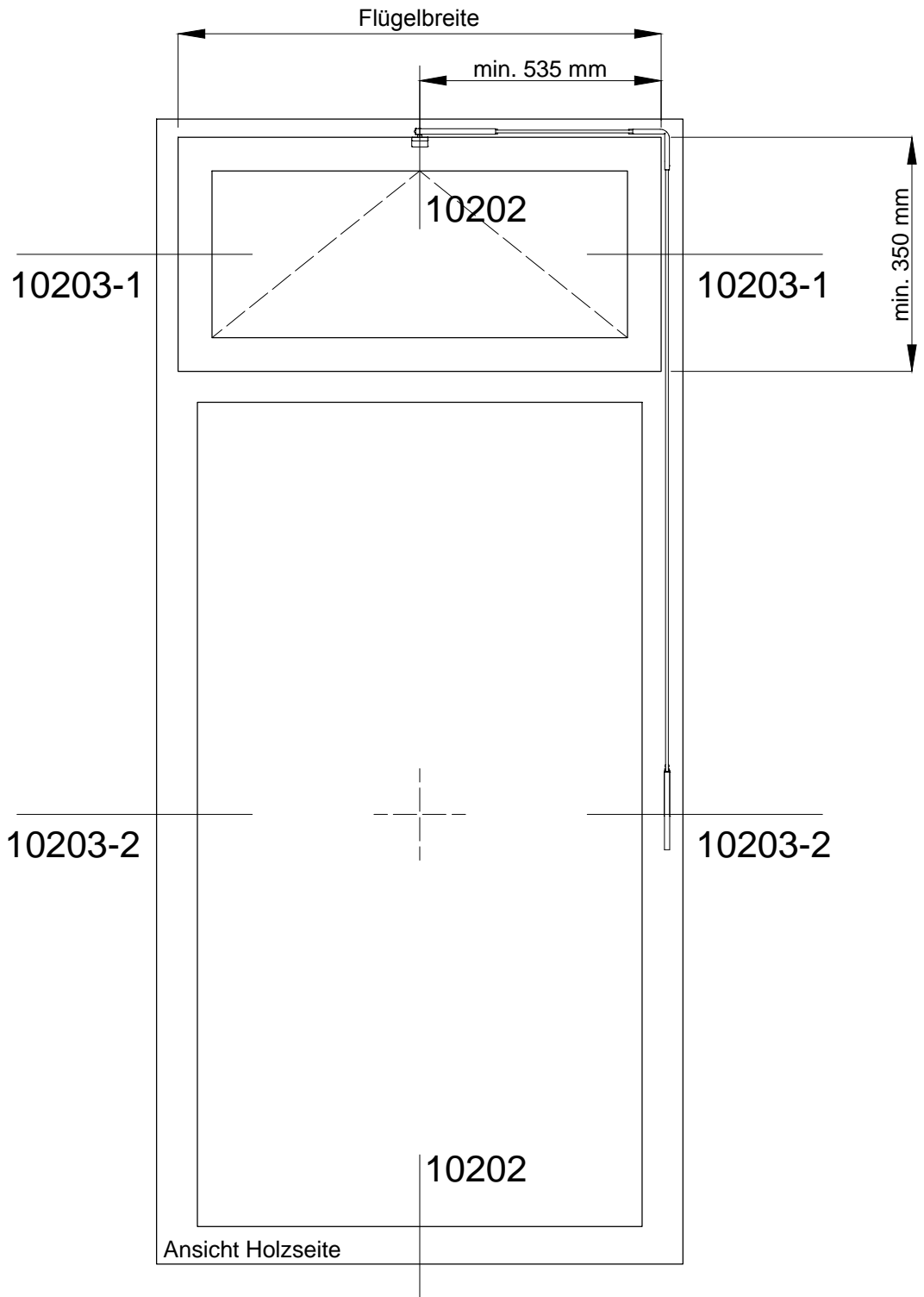

WSS GmbH & Co. KG			
ALU-KIPP 300			
Flügelbreiten	570 bis 1.200 mm eine Schere	1.201 bis 2.400 mm zwei Scheren	2.401 bis 3.600 mm drei Scheren
Flügelgewicht	max. 200 kg (abhängig von Flügelhöhe)		
Ausstellweite	300 mm		
Betätigungshub	68 mm		

batimet
Holz-Aluminium · Systeme · Fenster · Fassade

Enderstrasse 90 | D-01277 Dresden
Telefon: +49 (0) 351.81186.0
Telefax: +49 (0) 351.81186.11
info@batimet.de | www.batimet.de

System	Datum	Name	Maßstab	
batimet TA35 FVNG flächenversetzt kantig Oberlichtöffner + Handhebel - Innenansicht	Gezeich.	11.04.2018	Pickel	Ansicht M1:1
	Gepr.			Detail -
Beschreibung	Norm			
WSS GmbH & Co. KG ALU-KIPP 300 mit Handhebel	Zeichnungs-Nr.: 10201			Index: A

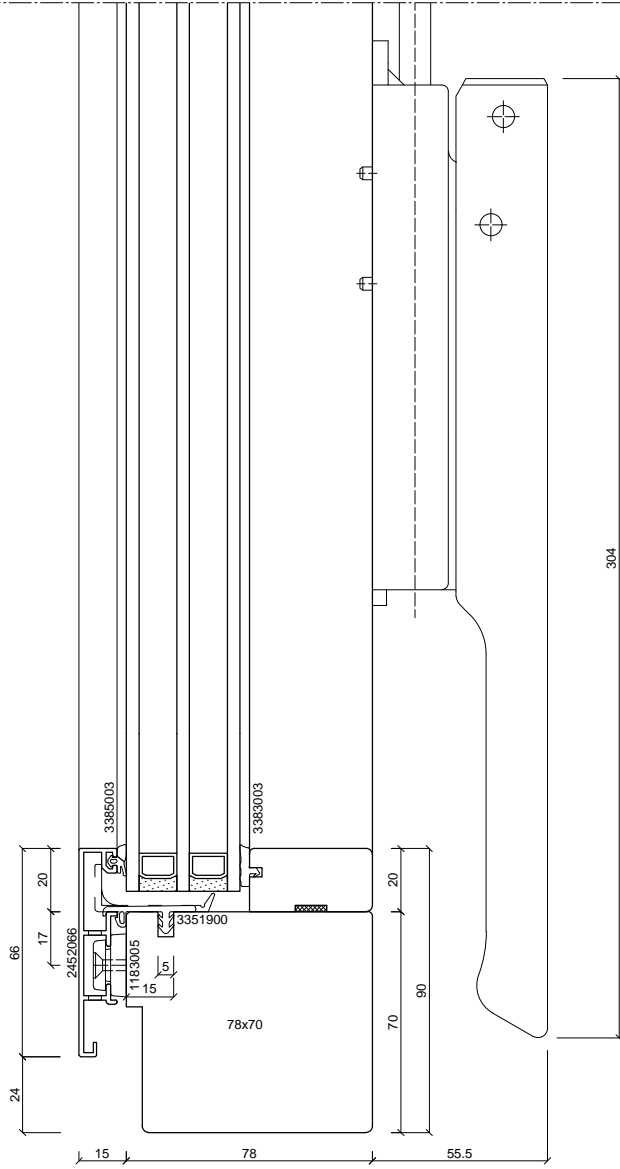
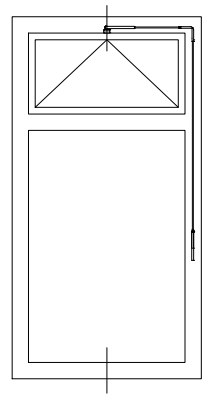
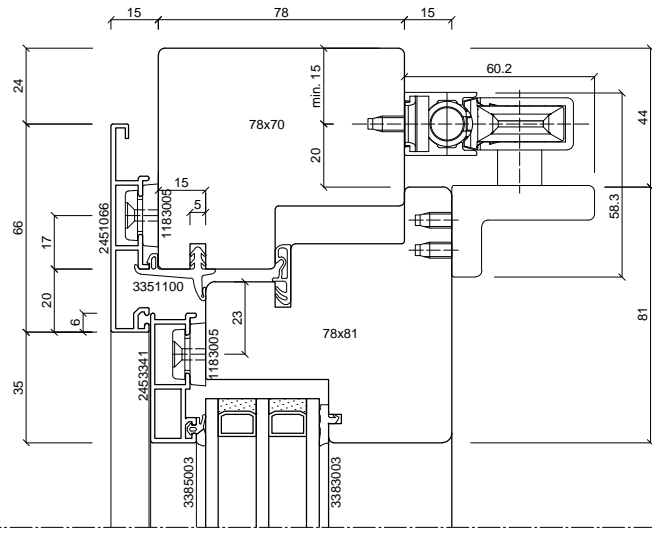

batimet
Holz-Aluminium · Systeme · Fenster · Fassade

Enderstrasse 90 | D-01277 Dresden
Telefon: +49 (0) 351.81186.0
Telefax: +49 (0) 351.81186.11
info@batimet.de | www.batimet.de

System		Datum	Name	Maßstab
batimet TA35 FVNG flächenversetzt kantig Vertikalschnitt	Gezeich.	11.04.2018	Pickel	Ansicht -
	Gepr.			Detail -
Beschreibung	Norm			
WSS GmbH & Co. KG ALU-KIPP 300 mit Handhebel	Zeichnungs-Nr.: 10202			Index: A

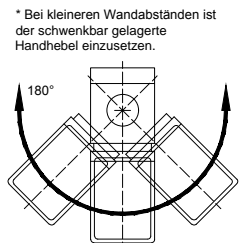
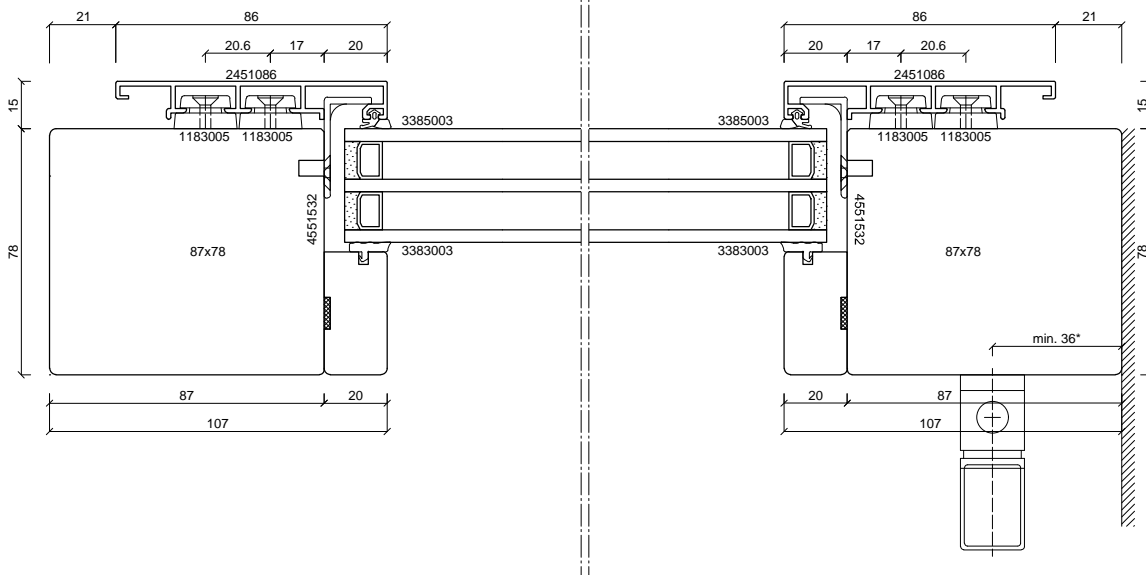
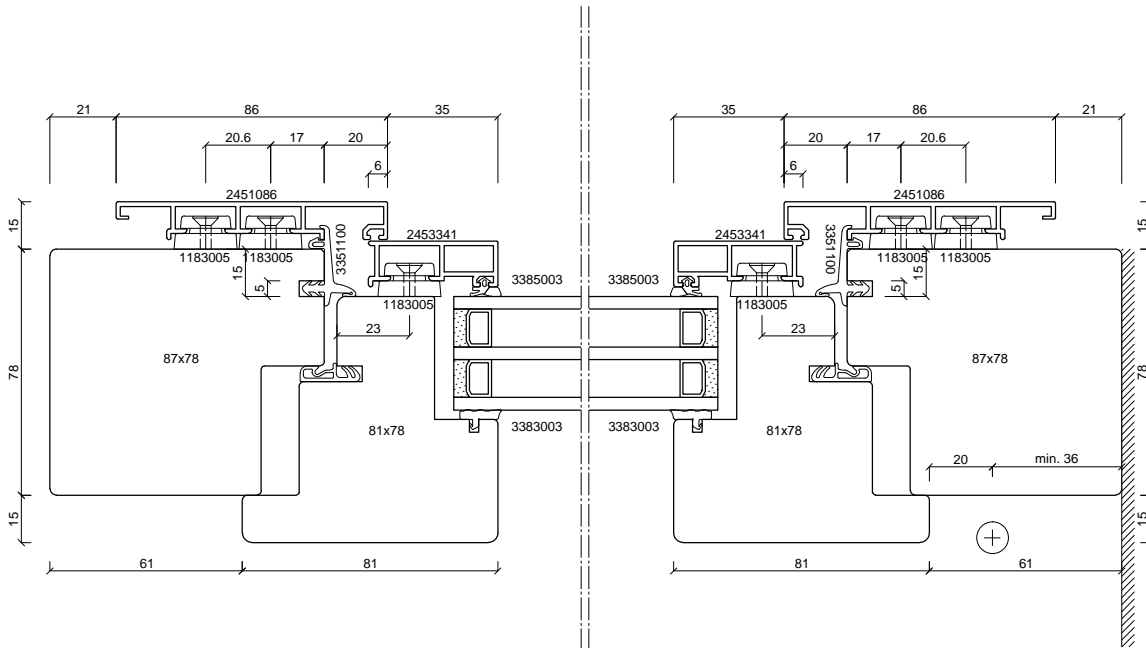
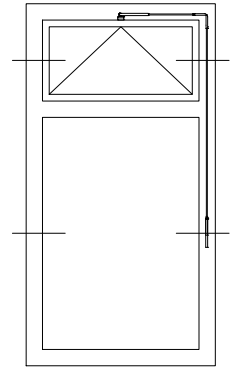

batimet

Holz-Aluminium · Systeme · Fenster · Fassade

Enderstrasse 90 | D-01277 Dresden

Telefon: +49 (0) 351.81186.0

Telefax: +49 (0) 351.81186.11

info@batimet.de | www.batimet.de

System

batimet TA35 FVNG
flächenversetzt kantig
Horizontalschnitt

Beschreibung

WSS GmbH & Co. KG
ALU-KIPP 300 mit Handhebel

Datum

11.04.2018

Name

Pickel

Maßstab

Ansicht -

Gezeich.

Gepr.

Norm

Detail -

Zeichnungs-Nr.: 10203

Index: A

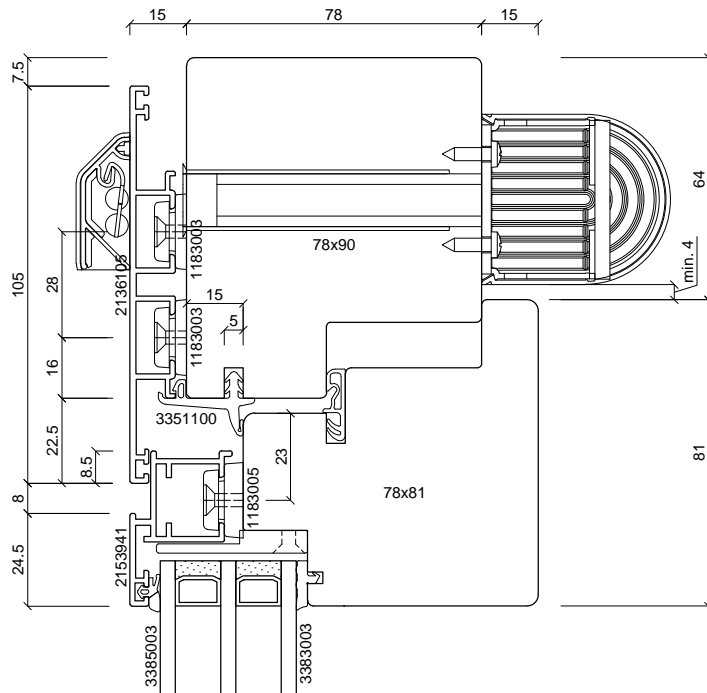
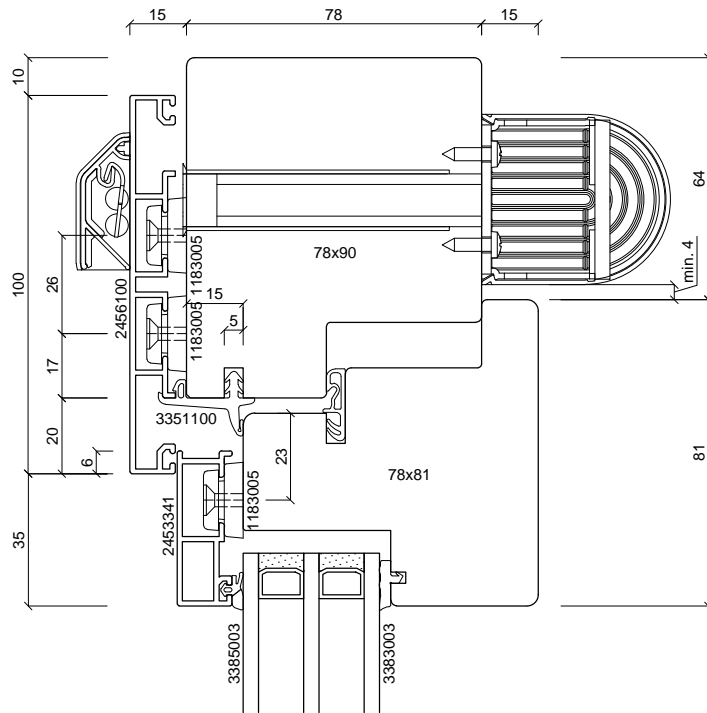

Renson				
Sonoslot Max				
Volumenstrom	2 Pa	4 Pa	8 Pa	10 Pa
	6,8 m³/h	10,6 m³/h	15,9 m³/h	18,3 m³/h
Schalldämmung in geöffnetem Zustand	40 (-1;-2) dB			
Länge	700 mm			
Oberfläche	RAL9016 / RAL1247			

batimet
Holz-Aluminium · Systeme · Fenster · Fassade

Enderstrasse 90 | D-01277 Dresden
Telefon: +49 (0) 351.81186.0
Telefax: +49 (0) 351.81186.11
info@batimet.de | www.batimet.de

System	Datum	Name	Maßstab	
batimet TA35 FVNG + FB5 flächenversetzt kantig + flächenbündig Vertikalschnitt aufgesetzter Fensterlüfter	Gezeich.	11.04.2018	Pickel	Ansicht -
	Gepr.			Detail -
Beschreibung	Norm			
Renson Sonoslot Max	Zeichnungs-Nr.: 10211			Index: A